

## [Warning Signs](#)

## [About This Guide](#)

## [Unboxing](#)

### [Check Before Installation](#)

### [What's in the Anker SOLIX Solarbank 2 E1600 Pro Box](#)

### [Optional Accessories](#)

## [Overview](#)

### [Product Overview](#)

### [Button Controls](#)

### [LED Guide](#)

## [Installing Your Solarbank](#)

### [Select an Installation Site](#)

### [What You Need](#)

### [Installation](#)

## [Electrical Connections](#)

### [Connecting Cables](#)

### [Turn On the Solarbank](#)

## [Using the App](#)

### [Download the App](#)

### [Account Registration](#)

## [Initialization Setting](#)

### [Network Configuration](#)

### [Add Home Devices \(Optional\)](#)

### [Firmware Update](#)



### [Power Mode Setting Initialization](#)

### [Energy Plan Setting](#)

## [FAQ](#)

## [Specifications](#)

## **Warning Signs**

	This sign signifies the presence of high voltage danger and risk of electric shock.
	To prevent electric shock or personal injury, refrain from touching or using the inverter until 3 minutes have lapsed since its shutdown or disconnection.
	Refer to the operation instructions.

## **About This Guide**

This guide shows the primary system for the whole-home photovoltaic energy cycle, with Anker SOLIX Solarbank 2 E1600 Pro installed as the main service equipment. This guide describes Anker SOLIX Solarbank 2 E1600 Pro in terms of unboxing, product overview, installation, electrical connections, button and light explanation, customer service, and safety guidelines.

- One Anker SOLIX Solarbank 2 E1600 Pro can support up to five Anker SOLIX BP1600 Expansion Battery modules.
- Anker SOLIX Solarbank 2 E1600 Pro can be used with Anker SOLIX Smart Meter.

## **Unboxing**

### **Check Before Installation**

#### **Check the Outer Packaging**

Before unpacking the equipment, check the outer packaging for damage, such as holes and cracks, and review the equipment model number. If any damage is found or the model is not what you requested, do not unpack the equipment and contact Anker customer service as soon as possible.

#### **Check Deliverables**

After unpacking the equipment, check that the deliverables are intact and complete, and free from any obvious damage. If any item is missing or damaged, contact Anker customer service.

### **What's in the Anker SOLIX Solarbank 2 E1600 Pro Box**

Model: A17C1

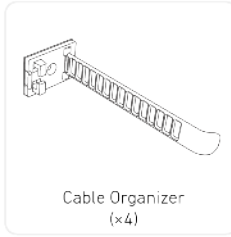
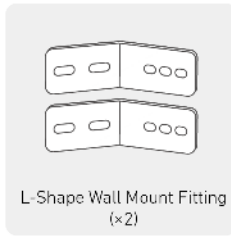

### Optional Accessories

The following accessories must be ordered separately.

#### Anker SOLIX BP1600 Expansion Battery (Optional)

Model: A17C13Z1-85

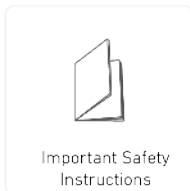

#### Anker SOLIX Smart Meter (Optional)

Model: A17X7

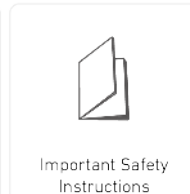
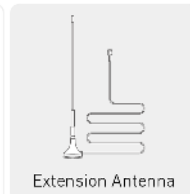
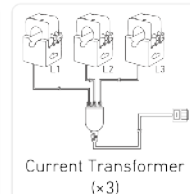
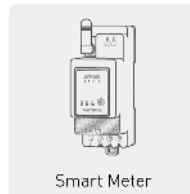

## Overview

### Product Overview

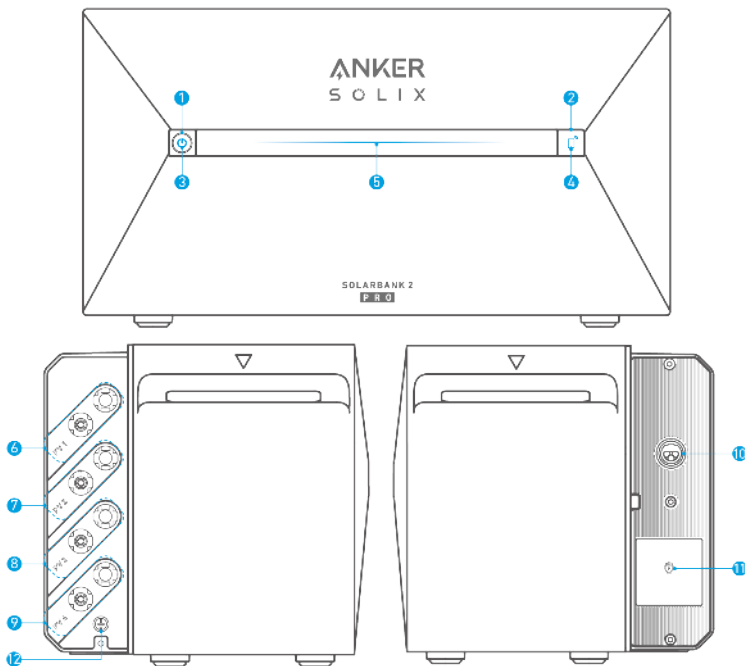



① Power Button





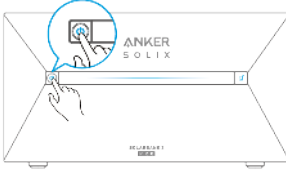

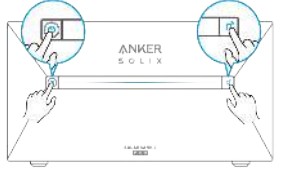
② IoT Button

- ③ Power Status LED
- ④ IoT Status LED
- ⑤ Working Status LED
- ⑥ MC4 Ports for PV Input 1
- ⑦ MC4 Ports for PV Input 2
- ⑧ MC4 Ports for PV Input 3
- ⑨ MC4 Ports for PV Input 4
- ⑩ Grid-Tied Terminal
- ⑪ Backup Terminal
- ⑫ Ground Screw Hole (Protective earthing conductor wire should be at least 26.6mm<sup>2</sup>)

### Button Controls

Button	Action	Function
	Press for 4 seconds	Turn on Solarbank
	Press for 2 seconds	Turn off Solarbank
	Press once when powered on	Check current battery level on
	Press once	Enable Internet connection
	Press for 2 seconds	Disable Internet connection
	Press for 7 seconds	Reset Bluetooth and Wi-Fi
	Simultaneously press for 9 seconds	Reset Solarbank

### LED Guide

Light Bar	Description	Status
	The center LED lights up toward both sides.	Powered on
	The lights on both sides fade toward the center.	Powered off
	The LED lights up toward both sides, and then cycle again.	Recharging
	The light bar changes according to battery level.	Battery level
	The light runs from right to left.	Upgrading OTA
	The power button light flashes red.	Malfunction / Warning

### Installing Your Solarbank

#### Select an Installation Site

##### Environment Requirements

- Do not place the modules near an area exposed to direct sunlight, fire, or explosive materials.
- Ensure the site is protected from potential hazards such as floods.
- The maximum operating altitude is 4,000 m (13,123 ft).

##### Measure the Distance

Reserve sufficient space for heat dissipation and safety isolation.

1. Select the appropriate installation space according to the equipment configuration to be installed.

Anker SOLIX Solarbank 2 E1600 Pro						
Expansion Battery Module	0	x1	x2	x3	x4	x5
Energy	1600Wh	3200Wh	4800Wh	6400Wh	8000Wh	9600Wh

2. Equipment Dimensions Figure:

Figure: Anker SOLIX Solarbank 2 E1600 Pro

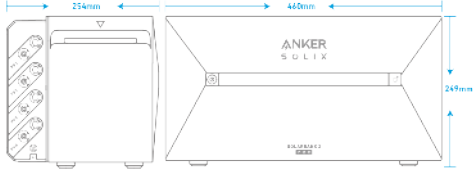
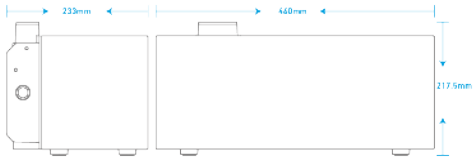

Figure: Anker SOLIX BP1600 Expansion Battery



What You Need

Anker SOLIX Solarbank 2 E1600 Pro	Multiple Anker SOLIX BP1600 Expansion Batteries	L-Shape Wall Mount Fitting (x2)
Fixed Bracket (x2)	M5x60 Self-Tapping Expansion Screws (x2)	M5x10 Combined Phillips Screws

Note: The following components are not included in this package. Please make sure they are ready before installation and electrical connection.

Phillips Screwdriver	Hammer	Drill (Screw Torque: 2N·m)

Installation

The steps below describe the installation of one Solarbank 2 E1600 Pro and two Expansion Batteries as an example.

1. Place one expansion battery on the floor 30mm from the wall.

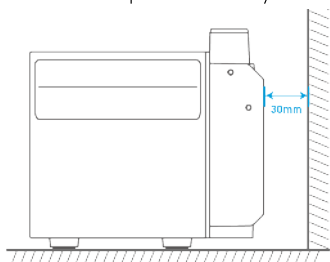

2. Use a Phillips screwdriver to pry open the rubber plug at the bottom of Solarbank and expansion batteries.

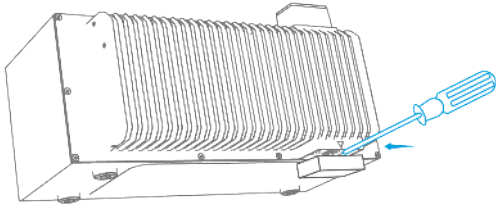
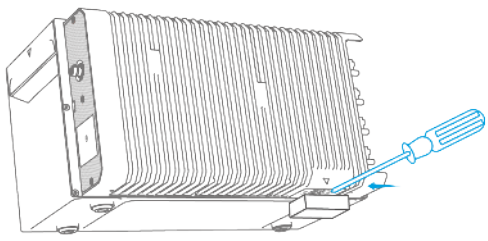

⚠ Note: When installing the bottom battery pack or only one Solarbank, please do not remove the bottom rubber plug to avoid water damage to the equipment.

3. Stack expansion batteries in sequence with Solarbank at the top by inserting the two corresponding ports into each other.

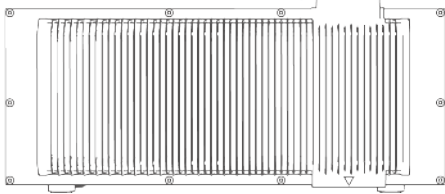
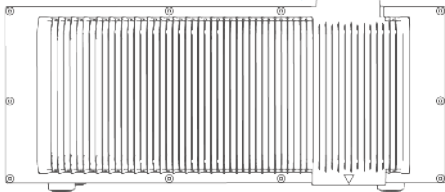
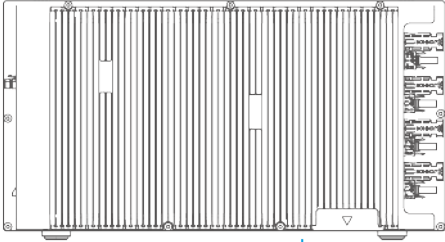

4. Pre-fasten the L-Shape Wall Mount Fitting to both sides of the first expansion battery under Solarbank using M5×10 combined Phillips screws.

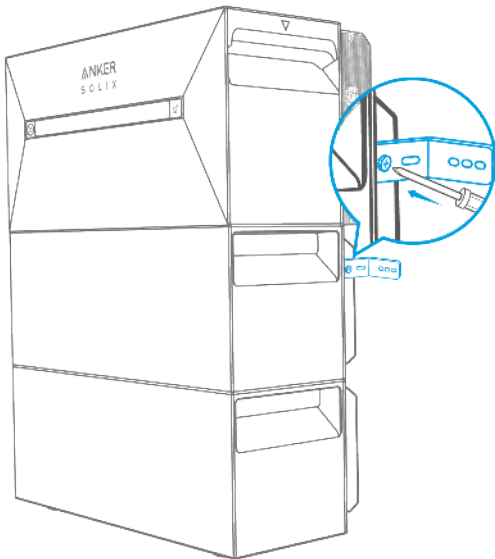

5. Mark the position of drilling holes on both sides and use a drill with a  $\phi 8$  drill bit and a depth of 60mm.

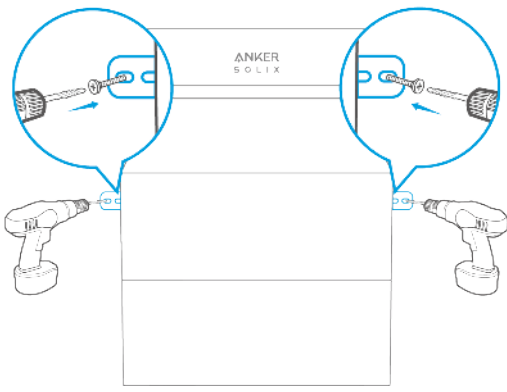

6. Use a hammer to tap the plastic sleeve of the M5x60 self-tapping expansion screw into the hole, and then use a Phillips screwdriver to fasten the M5x60 self-tapping screw against the L-Shape Wall Mount Fitting.

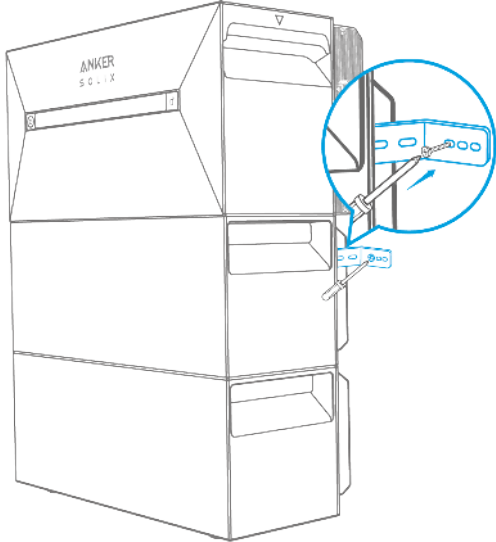

7. Use a Phillips screwdriver to fasten the M5x10 combination Phillips screws against the L-Shape Wall Mount Fitting; then secure the interlocking bracket to the expansion battery using the M5x10 combined Phillips screws to complete the installation.

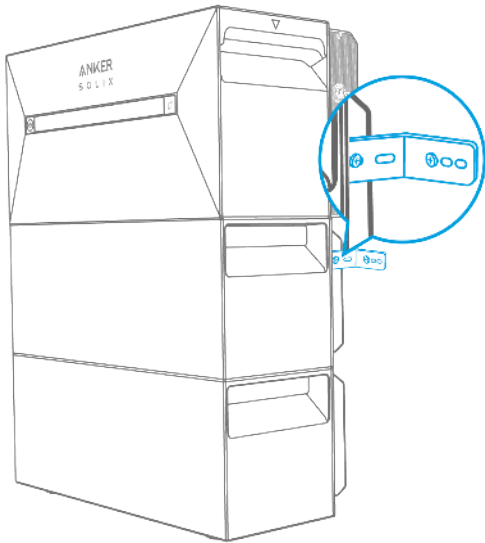

**Note:**

• The grid connection must be connected to a socket with grounding, otherwise there is a risk of electric shock. Alternatively, the casing should be grounded. The grounding point is shown below.

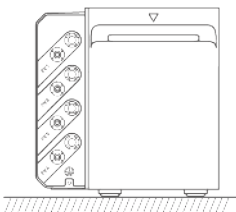

• This product includes a double isolation transformer, which meets safety requirements without array ground insulation resistance measurement and array residual current detection.

**Electrical Connections**

**Connecting Cables**

The steps below describe the installation of one Solarbank 2 E1600 Pro with four solar panels as an example.

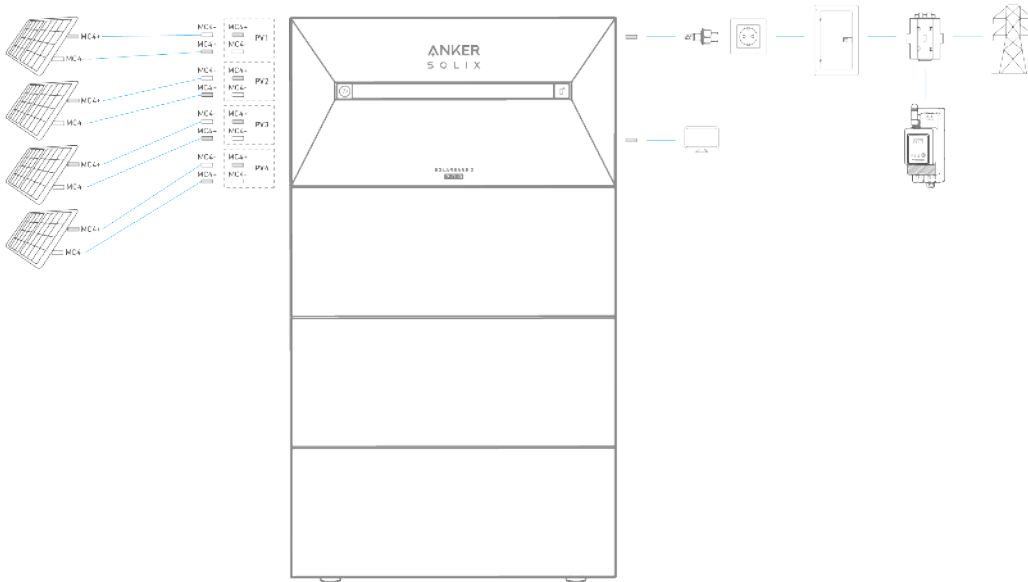

1. Connect Solarbank to a home outlet using the included AC Cable with Schuko plug (5m).

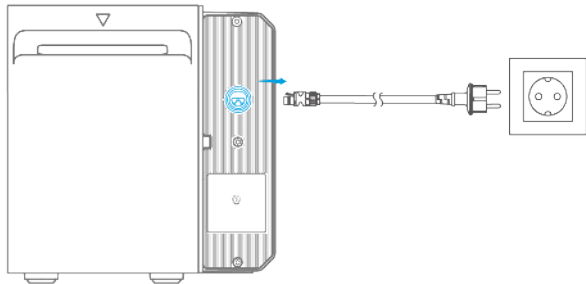

2. Find the MC4 ports of your solar panels.

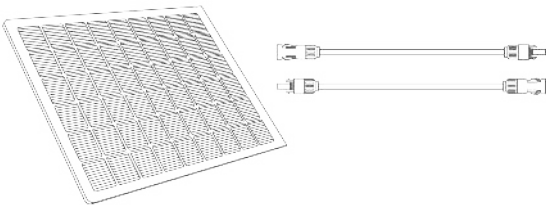

3. Connect each set of PV modules to each set of PV input ports in Solarbank using the included Anker SOLIX Solar Panel Extension Cable (3m).

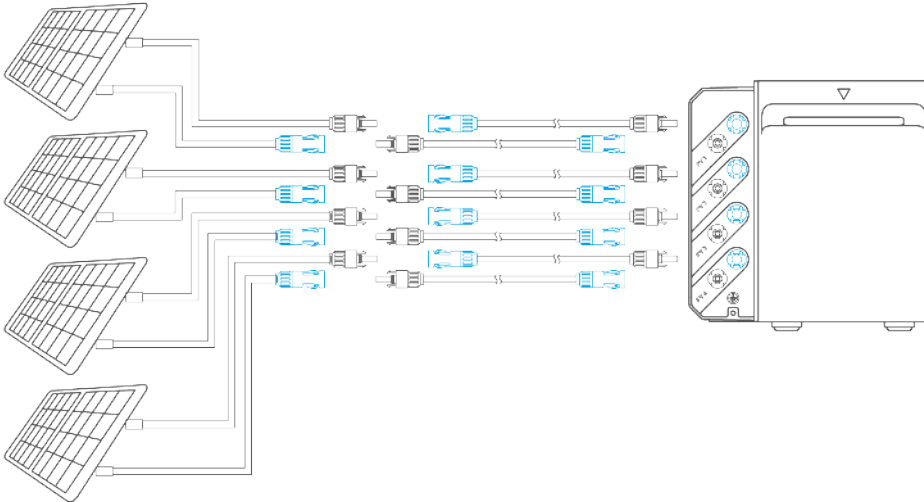

Solar Panels

Anker SOLIX Solarbank 2 E1600 Pro

Never connect two or more components in series because this causes the input voltage to exceed 60V and will damage the equipment.

**Turn On the Solarbank**

1. The first use requires the connection of a solar panel and a home outlet.

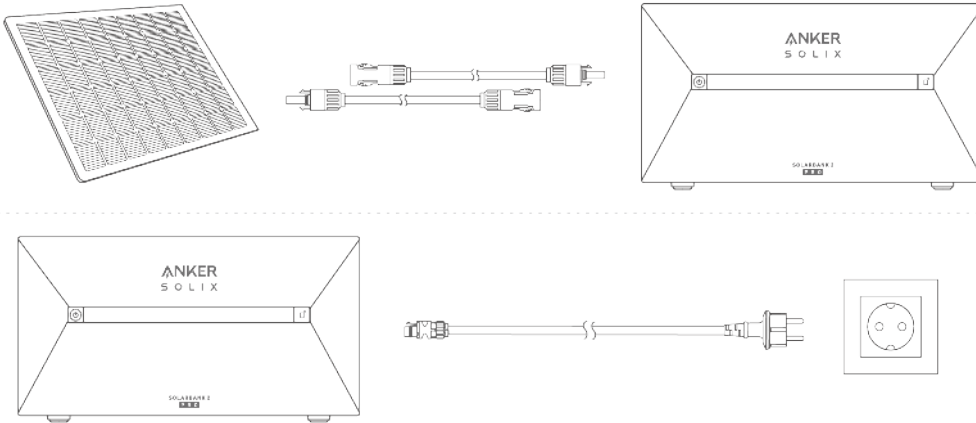

2. When you use it at night, you can press and hold the power button on the solarbank for 4 seconds to turn it on, which will enable network pairing. Please complete the network pairing with the app within 30 minutes. If the network pairing is not completed within 30 minutes, the Solarbank will automatically turn off.

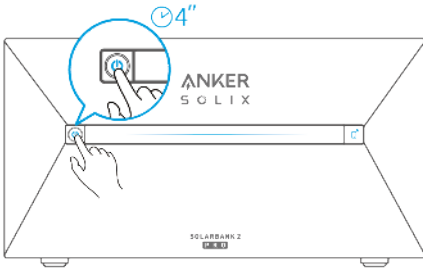

3. If you want to turn it off, please use the wrench to remove the solar panel extension cables on the device side and press the power button for 2 seconds.

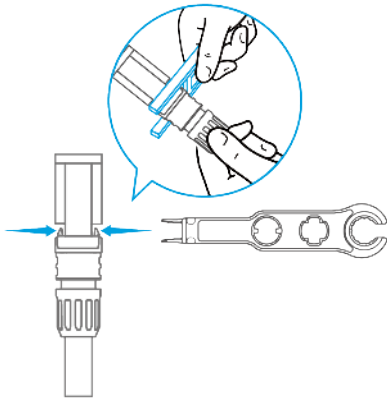

## Using the App

### Download the App

Search "Anker" and download the App via App Store or Google Play. Or scan QR code below to go to the corresponding application store.

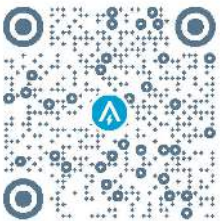

### Account Registration

#### Region Selection

When the app is launched, you will head to the login page.

Please be reminded that the country region **MUST** match where you live. An incorrect country region may cause the device connection to fail.

Country Selection



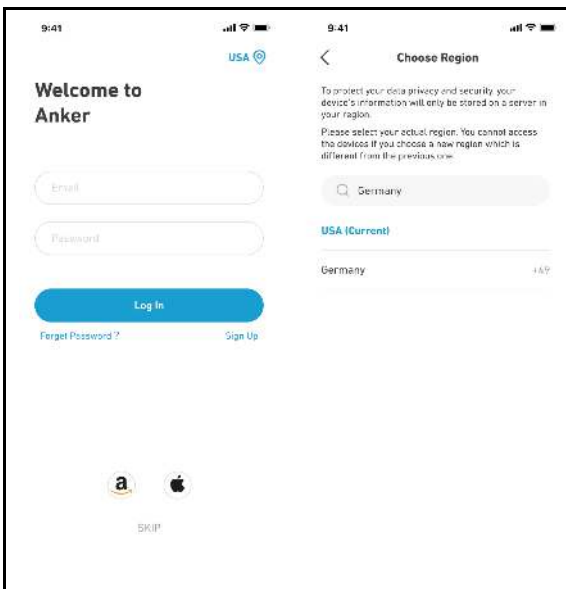

### Sign Up / Sign In

You can login via Anker account, Amazon, or Apple ID.

If you do not have an Anker account, you can tap [Sign Up] to register an account:

Please prepare an email for the registration process. Passwords must contain 8–20 characters using uppercase and lowercase letters, numbers, and symbols.

### Initialization Setting

#### Network Configuration

Before configuring, please ensure the network connection is working well with a strong Wi-Fi signal. Do not place the device far away from the router.

Step 1		<p>If Solarbank is powered off, press the left button on the device for 4 seconds to turn it on.</p>
Step 2		<p>Press the right button on the device, enable Wi-Fi mode.</p> <ul style="list-style-type: none"> <li>• When the IoT light flashes, the device is in Configuration mode.</li> <li>• If the device has configured Wi-Fi and you wish to reset it, you may hold the IoT button for 7 seconds.</li> </ul>
Step 3		<ol style="list-style-type: none"> <li>1. Keep the devices on.</li> <li>2. Tap [+] or [Add Device] at the top right corner of Devices page.</li> </ol>
Step 4		<p>The Anker app will automatically search for your Solarbank. Once the device is found, it will appear on the list.</p> <ul style="list-style-type: none"> <li>• Please make sure your phone's Bluetooth is on, and the Anker app is authorized to access Bluetooth and Wi-Fi.</li> <li>• If you wish to manually search for the device, you can tap [Balcony Solar System] in the "Add devices manually" row.</li> </ul>

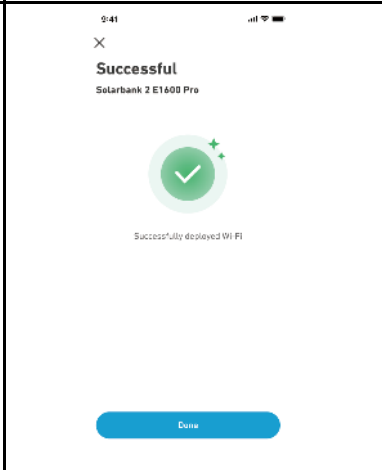
Step 5		<p>After connecting Solarbank via Bluetooth, you should choose a Wi-Fi network for the device. Select the Wi-Fi network from the list and enter the password.</p> <ul style="list-style-type: none"> <li>• The device only supports 2.4GHz Wi-Fi.</li> <li>• Make sure the password is correct.</li> </ul>
Step 6		<p>Your Solarbank should successfully be configured to the network.</p> <p>If the configuration process fails, follow the tips below:</p> <ul style="list-style-type: none"> <li>• Check if the Wi-Fi router is working normally.</li> <li>• Move the router closer to the device.</li> <li>• Make sure the Wi-Fi password is correct.</li> </ul>

### Add Home Devices (Optional)

If you have purchased Anker SOLIX Smart Meter, please scan the QR code below for more details.



Anker SOLIX Smart Meter can be added to the home system by following the process below. If you do not need to add any devices, you can skip the process by clicking [Skip].

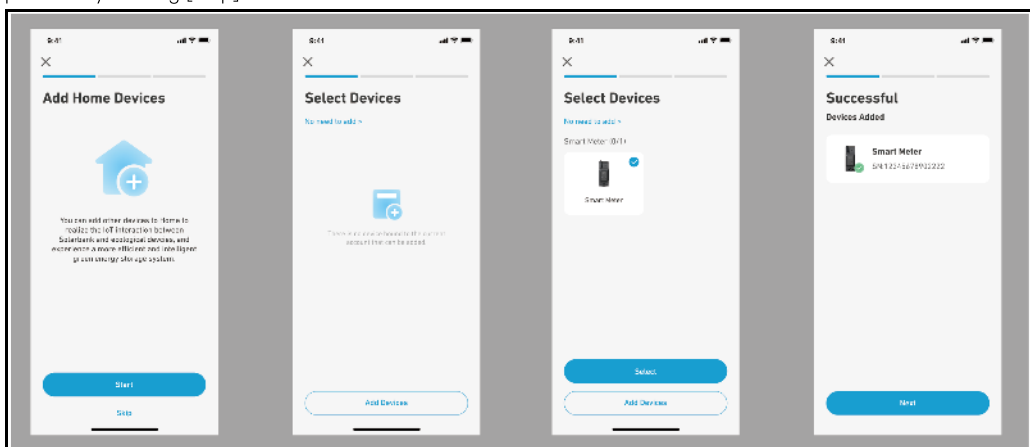

1. Click [Start] to begin the process of adding home devices.
2. Select the devices that have been bound to the current account. If you want to add devices that have not been bound to the account, then click [Add Devices].
3. Follow the process guide to activate the Smart Meter Bluetooth and pair your Smart Meter with Wi-Fi.
4. After pairing the Smart Meter, return to the [Add Devices] interface. At this time, you can see the Smart Meter in the list.
5. Select the Smart Meter to add it to the system.

### Firmware Update

Make sure all your devices have configured Wi-Fi and have a stable network connection.

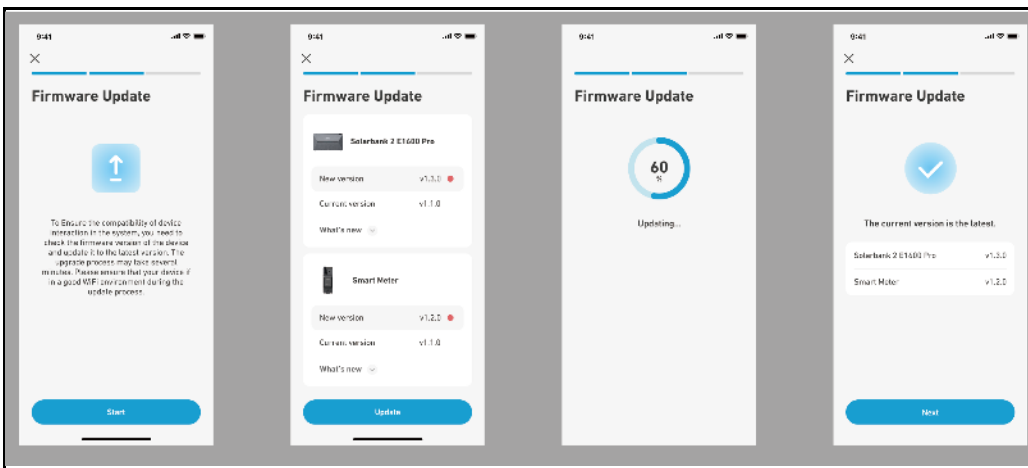

1. If there is an important update for the firmware of Solarbank or Smart Meter, the app will guide you to through the process. Make sure your devices are on and connected to Wi-Fi before updating.
  2. If no update is required, you can skip this step.
- \* Note: Updates can take a few minutes. Please be patient. If the update fails, check if your devices are activated and connected to Wi-Fi.

### Power Mode Setting Initialization

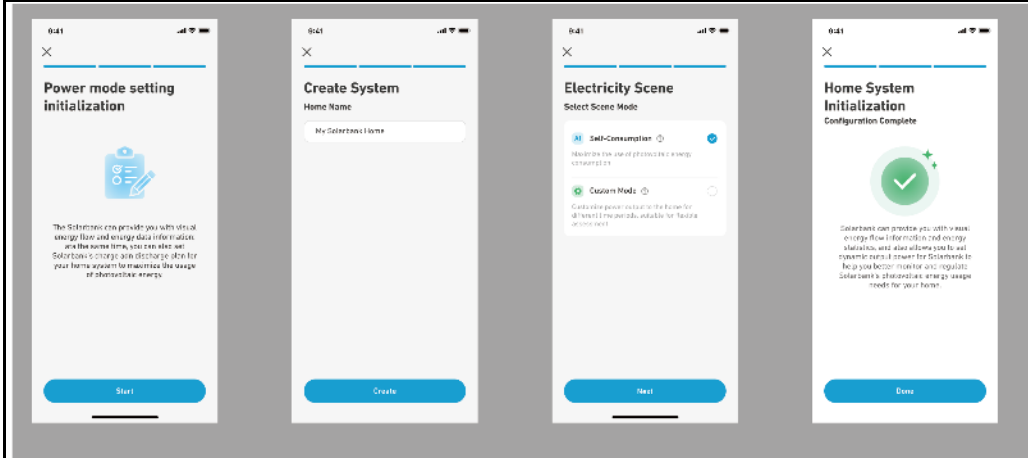

1. Tap [Create] to create a system for the previously added device.
  2. You can initially set up the system's energy plan with the following options:
    - Self-Consumption: Solarbank will intelligently perform the charging and discharging based on real-time power demand required by household loads obtained from the Smart Meter.
    - Custom Mode: You can set up a schedule for Solarbank to discharge a fixed amount of power into your home load at different time periods, and the extra energy will be stored in Solarbank.
- \*Note: Self-Consumption mode is only available when the Smart Meter is added to the system.

### Energy Plan Setting

#### About Energy Plan



In the Solarbank 2 E1600 Pro system, you can set up a charging and discharging plan. Solarbank will output the necessary amount of power to household loads at different time periods through the preset plan, and extra energy can be stored in Solarbank for reuse during the peak period of electricity consumption. This helps maximize use of solar energy.

Once you have configured the Smart Meter, you can also select Self-Consumption mode. The meter will intelligently manage Solarbank's discharging and energy storage in real time by obtaining only the amount of electricity required by household loads, not wasting solar energy.

Select Mode

Access mode selection from the Energy Plan shortcut on the Home page:

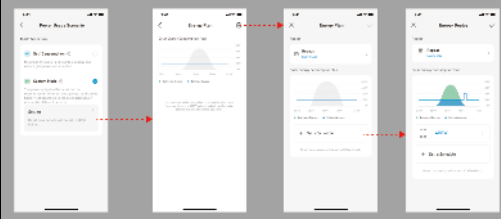
- Self-Consumption: In this mode, the Smart Meter calculates the power needed for household loads and sends it to Solarbank for efficient use of solar energy. Excess power is stored in the battery. This mode is only possible with a Smart Meter.
- Custom Mode: Manually create an electricity plan. Solarbank discharges household loads based on your inputs for different hourly timeframes. Extra energy is stored in the battery.
- Energy Plan can be set for each day of the week for a flexible energy solution for your family.

Custom Mode		<p>Select Custom Mode, then click the button below it:</p> <ol style="list-style-type: none"> <li>1. Tap [Settings] to enter the Energy Plan setting page, which will list all the plans you have set up. If there is no plan, Solarbank will discharge 200W to home loads at all times.</li> <li>2. Click [+] in the upper right corner to add a Energy Plan.</li> <li>3. On the Energy Plan page, click [Set a Schedule] to set the power that Solarbank discharges to household loads for different time periods.</li> <li>4. Tap [Repeat] above to repeat the set discharge plan for other weeks.</li> <li>5. After completing all settings, tap [✓] in the upper right corner to save and apply the Energy Plan.</li> </ol> <p>*Note:</p> <ul style="list-style-type: none"> <li>• You can add Energy Plan for multiple devices with different recurring dates.</li> <li>• Ensure that your device is connected to Wi-Fi when you save an electricity usage plan to synchronize the plan.</li> <li>• In Self-Consumption mode, if the Smart Meter goes offline or malfunctions, Solarbank automatically switches to Custom mode as a backup energy plan. This lasts until the Smart Meter returns to normal, and then Self-Consumption mode automatically resumes.</li> </ul>
		

## FAQ

1. Q: What precautions should I take before installing/adding expansion batteries?

A: When installing/adding expansion batteries, it is necessary to power off and shut down the system to protect yourself and the machine. Performing this operation while powered on is not covered under warranty. Please follow the steps below for proper installation:

- Disconnect Solarbank and the solar panels.
- Press the on/off button for 2 seconds to turn off the power.
- After turning off Solarbank, install the expansion batteries to Solarbank.
- Connect solar panels for normal use.

2. Q: Are there any other precautions that need to be taken when installing and using the product?

A: Ensure that the AC outlet is properly grounded.

3. Q: Can the photovoltaic panels be connected in series?

A: No. Never connect two or more components in series because this causes the input voltage to exceed 60V and will damage the equipment.

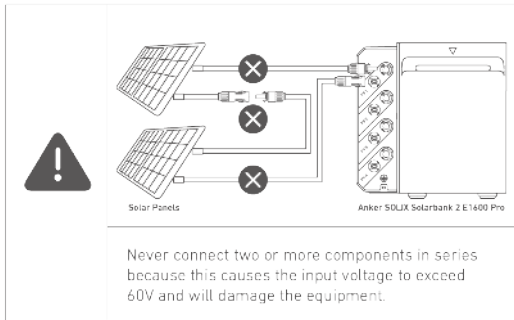

## Specifications

Specifications are subject to change without notice.

<b>Model</b>		A17C1
<b>Rated Capacity</b>		100Ah/1600Wh
<b>Rechargeable Li-Ion Battery</b>		LifePO4
<b>Wireless Connection</b>		Bluetooth, 2.4G Hz Wi-Fi
<b>PV Terminal</b>	Max PV Input Voltage	60VDC
	Max PV Input Current	16ADC (per channel)
	Max Isc PV	20ADC
	Max MPPT input power	2400W
	Operation Voltage Range	16-60VDC
	Number of MPPT	4
	Max Inverter Backfeed Current	0
<b>On-Grid Terminal</b>	AC Output Output	800W
	AC Rated Power	220/230/240VAC, 50/60Hz
	Max AC Output Current	3.5AAC, 230VAC
	Power Factor	1 (-0.8~+0.8)
	Max Output Fault Current	11A

	Max Output Overcurrent Protection	11A
	Inrush Current	23.6A
<b>Battery Terminal</b>	Battery Rated Voltage	16VDC
	Max Charge Current	75ADC
	Max Discharge Current	75ADC
	Rated Power	800W
	Max Charging Power	2000W(Add-On Battery)
	Max Discharging Power	1000W
	Expandable Battery Quantity	5
	Max Expandable Capacity	9600Wh
<b>Backup Terminal</b>	Max AC Output Power	1000W
	Max AC Apparent Power	1000VA
	AC Output	4.4AAC(max), 230VAC, 50/60Hz
	Max Output Fault Current	11A
	Max Output Overcurrent Protection	11A
	Power Factor	1 (-0.8~+0.8)
<b>General Parameters</b>	Charging Temperature Range	-20°C~55°C
	Discharging Temperature Range	-20°C~55°C
	Self-Heating	Yes, activated below 0°C
	Relative Humidity	5%~95%
	Maximum Altitude Rating	Below 4000m
	Ingress Protection	IP65
	Environmental Category	Outdoor Use
	Wet Location Classification	Wet Location
	Pollution Degree	PD3 (External) PD2 (Internal)
	Overvoltage Category	OVCII (DC), OVCIII (AC)
	Protective Class	Class I
	Warranty	10 Years
<b>Protection</b>	Overvoltage Protection	Yes
	Overcurrent Protection	Yes
	Short Circuit Protection	Yes
	Temperature Protection	Yes
	Overcharging Protection	Yes
	Over-Discharge Protection	Yes
<b>Dimensions and Weight</b>	Dimensions	460 × 249 × 254mm
	Net Weight	21.8kg